

Brandt



INSTRUCTION MANUAL EN

Dishwasher

**DFH14617W
DFH14617X**



Read this Manual

Dear Customer,

- Please carefully read this manual before using the dishwasher, it will help you use and maintain the dishwasher properly.
- Keep this manual for future reference.
- Pass it on to any subsequent owner of the appliance.

This manual contains sections on safety Instructions, Operating Instructions, Installation Instructions and Troubleshooting Tips, etc.



Before Calling for Service

- To review the section on troubleshooting Tips will help you to solve some common problems by yourself .
- If you can not solve the problems by yourself , please ask for the help of professional technicians.

NOTE:

- The manufacturer, following a policy of constant development and updating of the product, may make modifications without giving prior notice.
- If lost or out-of-date, you can receive a new user manual from the manufacturer or responsible vendor.

1) Safety Instructions.....	1-4
2) Quick user guide.....	5
3) Operating Instructions.....	6
Control Panel.....	6
Dishwasher Features.....	6
4) Prior to first time use.....	7
A. Water Softener.....	7
B. Loading the Salt into the Softener.....	8
C. Filling the Rinse Aid Dispenser.....	8
D. Function of Detergent.....	9
5) Preparing and loading dishes.....	12
Recommendations for loading and unloading the dishwasher.....	12
Standard loading pattern.....	13
6) Starting a washing program.....	14
Wash Cycle Table.....	14
Turning on the Appliance.....	14
Changing the Program mid-cycle.....	15
At the end of the Wash Cycle.....	15
7) Maintenance and cleaning.....	16
Filter System.....	16
Caring for the Dishwasher.....	17
8) Installation Instruction.....	18
Positioning the Appliance.....	18
About Power Connection.....	18
Water connection.....	19
Start of dishwasher.....	20
9) Troubleshooting Tips.....	21
Before calling for service.....	21
Error codes	22
Technical information.....	23

Loading the baskets according to En50242

1. IMPORTANT SAFETY INFORMATION



WARNING! When using your dishwasher, follow the precautions listed below:

- This appliance is intended to be used in household and similar applications such as:
 - staff kitchen areas in shops, offices and other working environments;
 - farm houses;
 - by clients in hotels, motels and other residential type environments;
 - bed and breakfast type environments.
- This appliance can be used by children aged from 8 years and above and persons with reduced physical, sensory or mental capabilities or lack of experience and knowledge if they have been given supervision or instruction concerning use of the appliance in a safe way and understand the hazards involved. Children shall not play with the appliance. Cleaning and user maintenance shall not be done by children without supervision. (For EN60335-1)
- Packaging material could be dangerous for children!
- This appliance is for indoor household use only.
- To protect against the risk of electrical shock, do not immerse the unit, cord or plug in water or other liquid.
- Please unplug before cleaning and performing maintenance on the appliance.
- Use a soft cloth moistened with mild soap, and then use a dry cloth to wipe it again.



EARTHING INSTRUCTIONS

- This appliance must be earthed. In the event of a malfunction or breakdown, earthing will reduce the risk of an electric shock by providing a path of least resistance of electric current. This appliance is equipped with an earthing conductor plug.
- The plug must be plugged into an appropriate outlet that is installed and earthed in accordance with all local codes and ordinances.
- Improper connection of the equipment-earthing conductor can result in the risk of an electric shock.
- Check with a qualified electrician or service representative if you are in doubt whether the appliance is properly grounded.
- Do not modify the plug provided with the appliance; If it does not fit the outlet.
- Have a proper outlet installed by a qualified electrician.
- Do not abuse, sit on, or stand on the door or dish rack of the dishwasher.
- Do not operate your dishwasher unless all enclosure panels are properly in place.
- Open the door very carefully if the dishwasher is operating, there is a risk of water squirting out.
- Do not place any heavy objects on or stand on the door when it is open. The appliance could tip forward.
- When loading items to be washed:
 - 1) Locate sharp items so that they are not likely to damage the door seal;

- 2) Warning: Knives and other utensils with sharp points must be loaded in the basket with their points facing down or placed in a horizontal position.
- Check that the detergent powder is empty after completion of the wash cycle.
 - Do not wash plastic items unless they are marked “dishwasher safe” or the equivalent.
 - For unmarked plastic items not so marked, check the manufacturer's recommendations.
 - Use only detergent and rinse agents recommended for use in an automatic dishwasher.
 - Never use soap, laundry detergent, or hand washing detergent in your dishwasher.
 - The door should not be left open, since this could increase the risk of tripping.
 - If the supply cord is damaged, it must be replaced by the manufacturer or its service agent or a similarly qualified person in order to avoid a hazard.
 - During installation, the power supply must not be excessively or dangerously bent or flattened.
 - Do not tamper with controls.
 - The appliance needs to be connected to the main water valve using new hose sets. Old sets should not be reused.
 - The maximum number of place settings to be washed is 14.
 - The maximum permissible inlet water pressure is 1MPa.
 - The minimum permissible inlet water pressure is 0.04MPa.

Disposal

- This appliance's packaging materials are recyclable. Dispose of the packaging into a suitable waste collection container to recycle it.
- It is prohibited to dispose of this appliance as household waste.



Correct Disposal of this product: this symbol on the product or in its packing indicates that this product may not be treated as household waste. Instead, it should be taken to the appropriate waste collection point for the recycling of electrical and electronic equipment. By ensuring this product is disposed of correctly, you will help prevent potential negative consequences for the environment and human health, which could otherwise be caused by the inappropriate waste handling of this product.



For more detailed information about the recycling of this product, please contact your local council your household waste disposal service, or the shop where you purchased the product.

WARNING!

- For disposing of package and the appliance please go to a recycling centre. Therefore cut off the power supply cable and make the door closing device unusable.
- Cardboard packaging is manufactured from recycled paper and should be disposed in the waste paper collection for recycling.
- By ensuring this product is disposed of correctly, you will help prevent potential negative consequences for the environment and human health, which could otherwise be caused by inappropriate waste handling of this product.
- For more detailed information about recycling of this product, please contact your local city office and your household waste disposal service.
- **DISPOSAL:** Do not dispose this product as unsorted municipal waste. Collection of such waste separately for special treatment is necessary.

2.Quick user guide

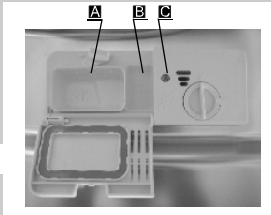
For detailed operating method read the corresponding content on the instruction manual.

Switch on the appliance	Press the Power switch button to switch on the appliance, Open the door.
Fill the detergent dispenser	<p>Compartment A: With each wash cycle.</p> <p>Compartment B: For programs with pre-wash only. (Follow the user instructions!)</p> 
Check the rinse aid level	<p>Mechanical indicator C. Electric indicator on control panel (if provided).</p>
Check the regeneration salt level	<p>(On models with water softener system only.) Electric indicator on control panel (if provided). If there is no salt warning light in the control panel (for some models), you can estimate when to fill the salt into the softener by the number of cycles the dishwasher has run.</p> 
Load the baskets	Scrape off any large amount of leftover food. Soften remnants of burnt food in pans, then load the baskets. Refer to the dishwasher loading instructions.
Select a program	Close the door,press the program button until the selected program lights up. (See the section entitled “Operation instruction”)
Running the dishwasher	To load the baskets, refer to the section entitled “Loading the Dishwasher Baskets” .
⋮	
<ul style="list-style-type: none"> • Changing the program 	<ul style="list-style-type: none"> • 1. A running cycle can only be modified if it has been running for a short time. Otherwise the detergent may have already been released and the water already drained. If this is the case, the detergent dispenser must be refilled. • 2. Press the Start/Pause button ,than press the program button more than 3 seconds to cancel the running program. • 3. Select a new program. • 4. Restart the dishwasher.
<ul style="list-style-type: none"> • Adding forgotten dishes in the dishwasher. 	<ul style="list-style-type: none"> • 1.Press the start/pause button to stop the machine. • 2.Open the door. • 3.Add the forgotten dishes. • 4.Close the door, then press the start/pause button, the dishwasher will start running again after 10 seconds.
<ul style="list-style-type: none"> • If the appliance is switched off during a wash cycle. 	<ul style="list-style-type: none"> • If the appliance is switched off during a wash cycle, when switched on again, please re-select the washing cycle and operate the dishwasher according to the original Power-on state).
⋮	
Switch off the appliance	When the working cycle has finished, the buzzer of the dishwasher will sound 8 times, then stop. Turn off the appliance using the On/Off Button,to turn off the appliance
Turn off the water tap, unload the baskets	Warning: wait a few minutes (about 15 minutes) before unloading the dishwasher to avoid handling the dishes and utensils while they are still hot and more susceptible to break. They will also dry better.Unload the appliance, starting from the lower basket.

⚠ WARNING!

Open the door carefully.
Look out for hot steam
when opening the door!

3. Operation Instruction

IMPORTANT To get the best performance from your dishwasher, read all operating instructions before using it for the first time.

Control Panel

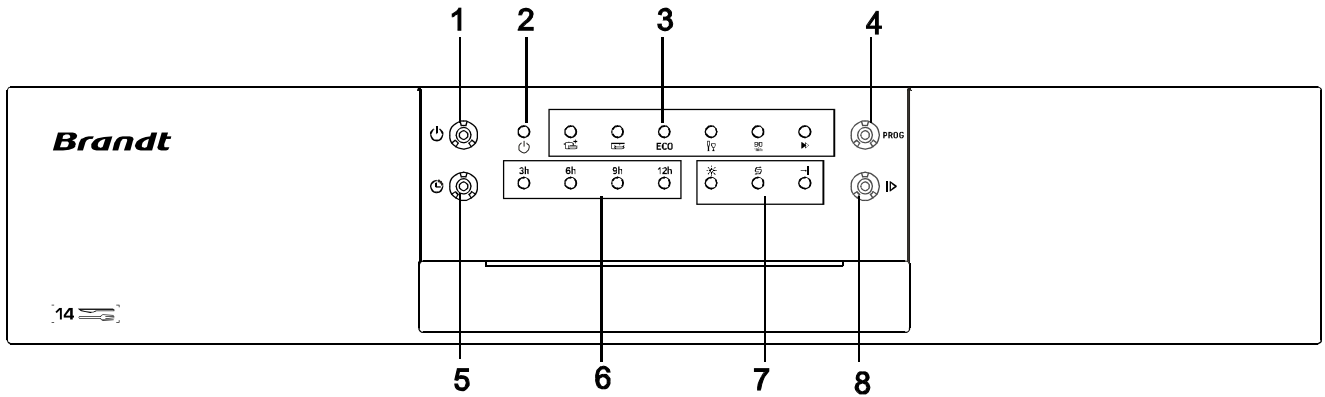

1. On/Off Button: To turn on/off the power supply.

2. Power indicator: To show when the power is on.

3. Program indicators: to show which program you have chosen;

4. Washing Program Button: Press the button to select a wash program

5. Delay Button: Press the button to delay.

6. Delay indicators: to show the delay time (3h/6h/9h/12h)

7. Salt S and rinse R aid warning lights: To show when the salt container or rinse aid dispenser needs to be refilled

8. Finish light: to show when the washing program is finished

8. Start /Pause Button: To start the selected washing program or to pause the washing program when the machine is working.

Dishwasher Features

Front view

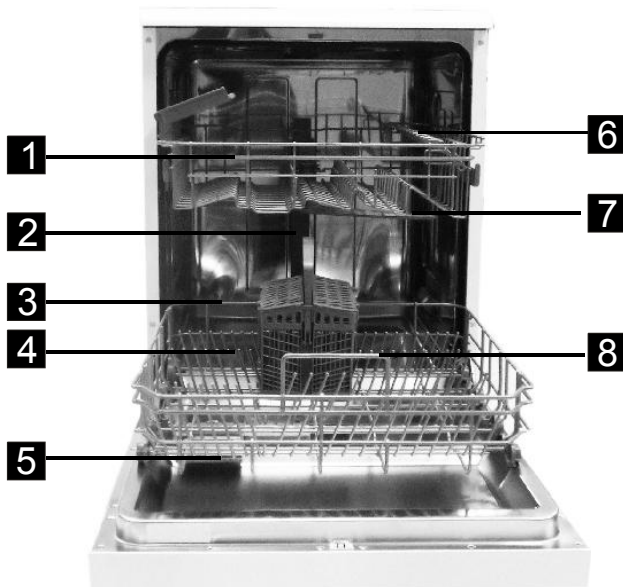

Back View

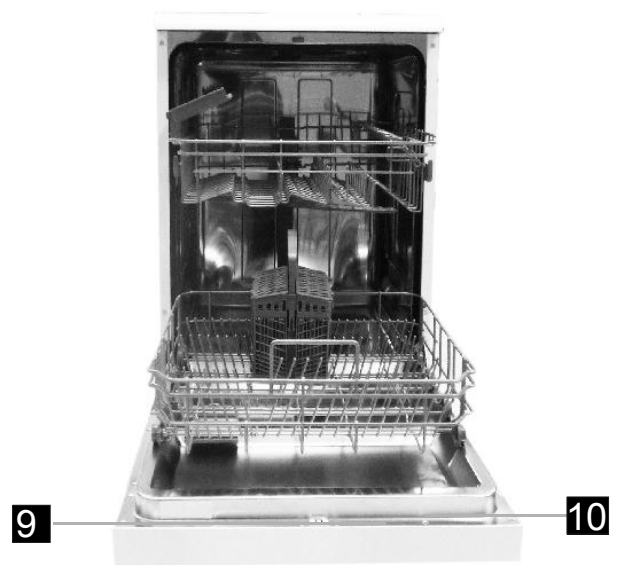

1 Upper Basket

2 Inner pipe

3 Lower Basket

4 Salt Container

5 Dispenser

6 Cup Shelf

7 Spray arms

8 Filter assembly

9 Inlet pipe connector

10 Drain pipe

4. Prior using for the first time

Before using your dishwasher for the first time:

- A.** Set the water softener
- B.** Add 1.5Kg dishwasher salt and then full fill the salt container with water
- C.** Fill the rinse aid dispenser
- D.** Fill in detergent

A. Water Softener

The water softener must be set manually, using the water hardness dial.

The water softener is designed to remove minerals and salts from the water, which would have a detrimental or adverse effect on the operation of the appliance.

The higher the content of these minerals and salts, the harder your water is.

The softener should be adjusted according to the hardness of the water in your area. Your local Water Authority can advise you on the hardness of the water in your area.

Adjusting Salt Consumption

The dishwasher is designed to allow for adjustment in the amount of salt consumed based on the hardness of the water used. This is intended to optimise and customise the level of salt consumption.

Please follow the steps below for adjustment in salt consumption.

1. Switch on the appliance;
2. Press the Start/Pause button for more than 5 seconds to start the water softener set model within 60 seconds after the appliance was switched on;
3. Press the Start/Pause button to select the proper set according to your local environment, the sets will change in the following sequence: H1->H2->H3->H4->H5->H6;
4. Press the Start/Pause button to end the set up model.

WATER HARDNESS				Selector Position	Salt consumption (gram/cycle)
°dH	°fH	°Clarke	mmol/l		
0~5	0~9	0~6	0~0.94	H1(Rapid Light brights)	0
6-11	10-20	7-14	1.0-2.0	H2(90 Min Light brights)	9
12-17	21-30	15-21	2.1-3.0	H3(90 Min、Rapid Lights bright)	12
18-22	31-40	22-28	3.1-4.0	H4(Glass Light brights)	20
23-34	41-60	29-42	4.1-6.0	H5(Glass、Rapid Lights bright)	30
35-55	61-98	43-69	6.1-9.8	H6(Glass、90 Min Lights bright)	60

Note:1

$$1^{\circ}\text{dH}=1.25^{\circ}\text{Clarke}=1.78^{\circ}\text{fH}=0.178\text{mmol/l}$$

°dH: German degree

°fH: French degree

°Clark: British degree

Note:2

The manufactory setting: **H3** (EN 50242)

Contact your local water board for information on the hardness of your water supply.



NOTE: If your model does not have any water softener, you may skip this section.

WATER SOFTENER

The hardness of the water varies from place to place. If hard water is used in the dishwasher, deposits will form on the dishes and utensils.

The appliance is equipped with a special softener that uses a salt container specifically designed to eliminate lime and minerals from the water.

B. Loading the Salt Into the Softener

Always use salt intended for dishwasher use.

The salt container is located beneath the lower basket and should be filled as explained in the following:

Warning!

- Only use salt specifically designed for dishwashers use! Every other type of salt not specifically designed for dishwasher use, especially table salt, will damage the water softener. In case of damages caused by the use of unsuitable salt the manufacturer does not give any warranty nor is liable for any damages caused.
- Only fill with salt just before starting one of the complete washing programs. This will prevent any grains of salt or salty water, which may have been spilled, remaining on the bottom of the machine for any period of time, which may cause corrosion.

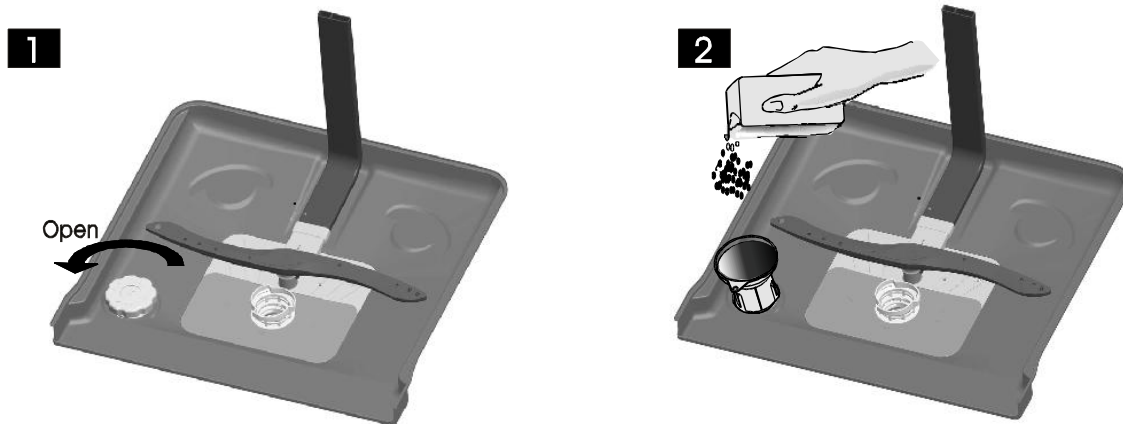

- A** After the lower basket has been removed, unscrew and remove the cap from the salt container. **1**
- B** Place the end of the funnel (supplied) into the hole and pour in about 1.5kg of dishwasher salt.
- C** Fill the salt container to its maximum limit with water, it is normal for a small amount of water to come out of the salt container. **2**
- D** After filling the container, screw back the cap tightly.
- E** The salt warning light will stop being on after the salt container has been filled with salt.
- F** Immediately after filling the salt into the salt container, a washing program should be started (We suggest to use a short program). Otherwise the filter system, pump or other important parts of the machine may be damaged by salty water. This is out of warranty.

! NOTE:

1. The salt container must only be refilled when the salt warning light in the control panel comes on. Depending on how well the salt dissolves, the salt warning light may still be on even though the salt container is filled. If there is no salt warning light in the control panel (for some Models), you can estimate when to fill the salt into the softener by the cycles that the dishwasher has run.
2. If salt has spilled, run a soak or quick program to remove it.

C. Filling the Rinse Aid Dispenser

Rinse Aid Dispenser

The rinse aid is released during the final rinse to prevent water from forming droplets on your dishes, which can leave spots and streaks. It also improves drying by allowing water to roll off the dishes. Your dishwasher is designed to use liquid rinse aids. The rinse aid dispenser is located inside, on the door and next to the detergent dispenser.

To fill the dispenser, open the cap and pour the rinse aid into the dispenser until the level indicator turns completely black. The volume of the rinse aid container is about 110ml.

Function of Rinse Aid

Rinse aid is automatically added during the last rinse, ensuring thorough rinsing, a spot and streak free drying.

Warning!

Only use branded rinse aid for dishwasher. Never fill the rinse aid dispenser with any other substances (e.g. Dishwasher cleaning agent, liquid detergent). This would damage the appliance.

When to Refill the Rinse Aid Dispenser

If there is no rinse-aid warning light in the control panel, you can estimate the amount from the colour of the optical level indicator "C" located next to the cap. When the rinse-aid container is full, the whole indicator will be dark. As the rinse-aid diminishes, the size of the dark dot decreases. You should never let the rinse aid level fall 1 / 4 full.

As the rinse aid diminishes, the size of the black dot on the rinse aid level indicator changes, as illustrated below.

- Full
- ◐ 3 / 4 full
- ◑ 1 / 2 full
- ◒ 1 / 4 full - Should refill to eliminate spotting
- Empty

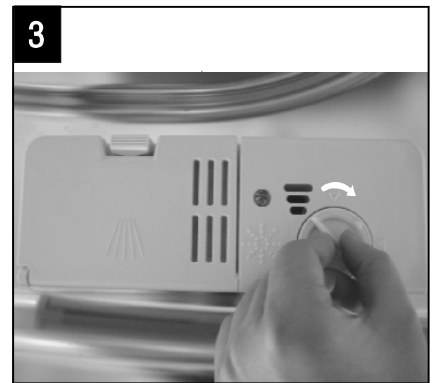
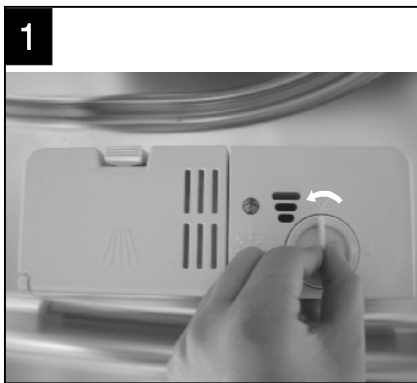
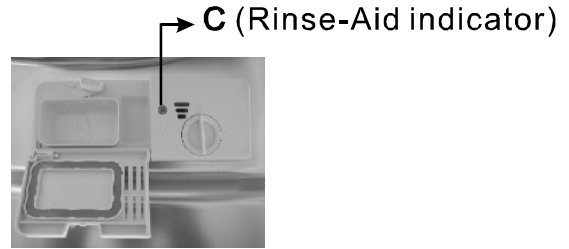

- 1** To open the dispenser, turn the cap to the "open" (left) arrow and lift it out.
- 2** Carefully pour in the rinse-aid into its dispenser, whilst avoiding it to overflow.
- 3** Replace the cap by inserting it aligned with "open" arrow and turning it to the closed (right) arrow.

! NOTE: Clean up any rinse aid spilled while during filling with an absorbent cloth to avoid excessive foaming during the next wash. Don't forget to replace the cap before close the dishwasher door.

Adjusting Rinse Aid Dispenser

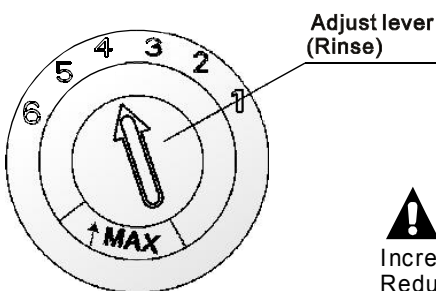

The rinse aid dispenser has six or four settings. Always start with the dispenser set on "4". If spots and poor drying are a problem, increase the amount of rinse aid dispensed by removing the dispenser lid and rotating the dial to "5". If the dishes still are not drying properly or show spots, adjust the dial to the next higher lever until your dishes are spot-free. The recommended setting is "4". (Factory value is "4".)

! NOTE: Increase the dose if there are drops of water or lime spots on the dishes after washing. Reduce it if there are sticky whitish stains on your dishes or a bluish film on glassware or knife blades.

D. Function of Detergent

The chemical ingredients that compose the detergent are necessary to remove, crush and dispense all dirt out of the dishwasher. Most of the commercial quality detergents are suitable for this purpose.

Attention!

Proper Use of Detergent
 Use only detergent specifically made for dishwasher use. Keep your detergent fresh and dry.
 Don't put powdered detergent into the dispenser until you are ready to wash dishes.

Detergents

There are 3 sorts of detergents

1. With phosphate and with chlorine
2. With phosphate and without chlorine
3. Without phosphate and without chlorine

Normally new pulverised detergent is without phosphate. Thus the water softener function of phosphate is not given. In this case we recommend to fill salt in the salt container even when the hardness of water is only 6 °dH. If detergents without phosphate are used in the case of hard water often white spots appear on dishes and glasses. In this case please add more detergent to reach better results. Detergents without chlorine do only bleach a little. Strong and coloured spots will not be removed completely. In this case please choose a program with a higher temperature.

Concentrated Detergent

Based on their chemical composition, detergents can be split in two basic types:

- conventional, alkaline detergents with caustic components
- low alkaline concentrated detergents with natural enzymes

Detergent Tablets

Detergent tablets of different brands dissolve at different speeds. For this reason some detergent tablets cannot dissolve and develop their full cleaning power during short programs. Therefore please use long programs when using detergent tablets, to ensure the complete removal of detergent residuals.

Detergent Dispenser

The dispenser must be refilled before the start of each wash cycle following the instructions provided in the wash cycle table. Your dishwasher uses less detergent and rinse aid than Conventional dishwasher. Generally, only one tablespoon of detergent is needed for a normal wash load. More heavily soiled items need more detergent. Always add the detergent just before starting the dishwasher, otherwise it could get damp and will not dissolve properly.

Amount of Detergent to Use

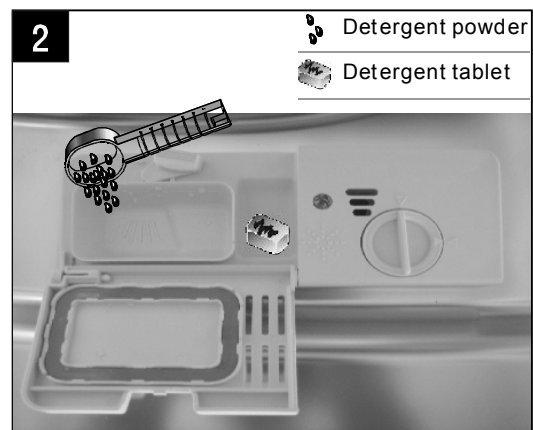
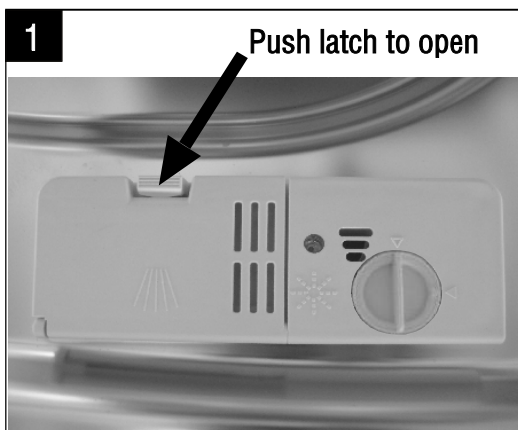

⚠ NOTE:

- If the lid is closed: press release button. The lid will spring open.
- Always add the detergent just before starting each wash cycle.
- Only use branded detergent aid for dishwasher.

⚠ WARNING!

Dishwasher detergent is corrosive!
Take care to keep it out of reach of children.

Filling in detergent dispenser

Fill the detergent dispenser with detergent. The marking indicates the dosing levels, as illustrated on the right:

- A** Place the main wash cycle detergent here.
- B** Place the pre-wash cycle detergent here.

Please observe the manufacturers dosing and storage Recommendations as stated on the detergent packaging.

Close the lid and press on it until it locks into place.

If the dishes are heavily soiled, place an additional detergent dose in the pre-wash detergent chamber. This detergent will take effect during the pre-wash phase.

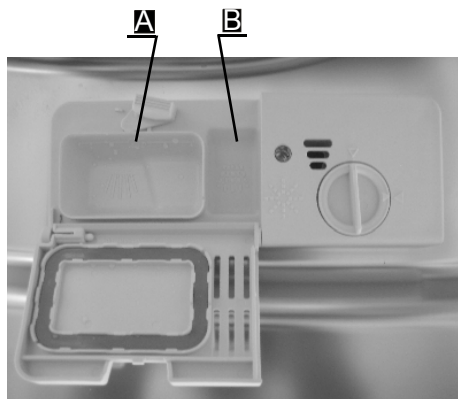

! *NOTE:*

- You will find information about the amount of detergent for the single program on page 14.
- Be aware that depending on the soiling of water, setting may be different.
- Please observe the manufacturer's recommendations on the detergent packaging.

5. Preparing and loading dishes

Recommendation

- Consider buying utensils which are identified as dishwasher-proof.
- Use a mild detergent that is described as 'kind to dishes'. If necessary, seek further information from the detergent manufacturers.
- For particular items, select a program with the lowest possible temperature.
- To prevent damage, do not take glass and cutlery out of the dishwasher immediately after the program has ended.

For washing in the dishwasher the following cutlery/dishes

Are not suitable

- Cutlery with wooden, horn china or mother-of-pearl handles
- Plastic items that are not heat resistant
- Older cutlery with glued parts that are not temperature resistant
- Bonded cutlery items or dishes
- Pewter or copper items
- Crystal glass
- Steel items subject to rusting
- Wooden platters
- Items made from synthetic fibres

Are of limited suitability

- Some types of glasses can become dull after a large number of washes
- Silver and aluminum parts have a tendency to discolour during washing
- Glazed patterns may fade if machine washed frequently

Attention before or after loading the Dishwasher Baskets

(For best performance of the dishwasher, follow these loading guidelines.
Features and appearance of baskets and cutlery baskets may vary from your model.)

Scrape off any large amounts of leftover food. Soften remnants of burnt food in pans.
It is not necessary to rinse the dishes under running water.

Place objects in the dishwasher in following way:

1. Items such as cups, glasses, pots/pans, etc. are faced downwards.
2. Curved items, or ones with recesses, should be loaded aslant so that water can run off.
3. All utensils are stacked securely and can not tip over.
4. All utensils are placed in the way that the spray arms can rotate freely during washing.



NOTE: Very small items should not be washed in the dishwasher as they could easily fall out of the basket.

- Load hollow items such as cups, glasses, pans etc. With the opening facing downwards so that water cannot collect in the container or a deep base.
- Dishes and items of cutlery must not lie inside one another, or cover each other.
- To avoid damage, glasses should not touch one another.
- Load large and difficult to clean items in the lower basket.
- The upper basket is designed to hold more delicate and lighter dishware such as glasses, coffee and tea cups
- Long bladed knives stored in an upright position are a potential hazard!
- Long and/or sharp items of cutlery such as carving knives must be positioned horizontally in the upper basket.
- Please do not overload your dishwasher. This is important for good results and for reasonable consumption of energy.

Removing the Dishes

To prevent water dripping from the upper basket into the lower basket, we recommend that you empty the lower basket first, followed by the upper basket.

Standard Loading Pattern

A. Loading the Upper Basket

The upper basket is designed to hold more delicate and lighter dishware such as glasses, coffee and tea cups and saucers, as well as plates, small bowls and shallow pans (as long as they are not too dirty). Position the dishes and cookware so that they will not get moved by the spray of water.

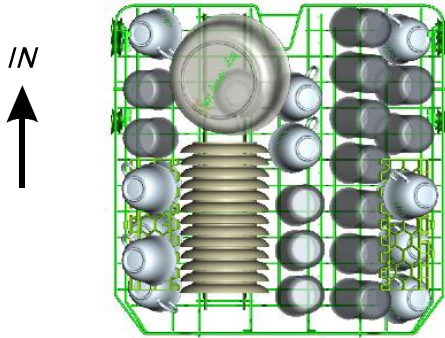

Please be reminded that:

- Pots, serving bowls, etc, must always be placed top down.
- Deep pots should be slanted to allow water to flow out.
- The Bottom Basket features folding spikes so that larger or more pots and pans can be loaded.

B. Loading the Lower Basket

We suggest that you place large items and the most difficult to clean items into the lower basket: such as pots, pans, lids, serving dishes and bowls, as shown in the figure below. It is preferable to place serving dishes and lids on the side of the racks in order to avoid blocking the rotation of the top spray arm. The maximum diameter advised for plates in front of the detergent dispenser is of 19 cm, this not to hamper the opening of it

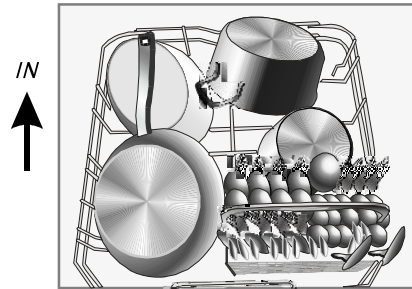

C. Adjusting the Upper Basket

The height of the upper rack can be easily adjusted to accommodate taller dishes in either the upper and lower rack. The height of the upper basket can be adjusted by placing the wheels on different height of the rails.

Lower position Upper position

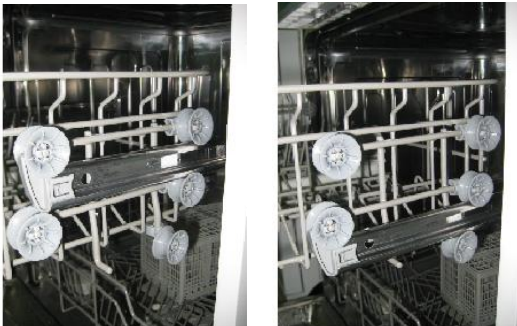

Wheels

D. Folding back the cup Shelves

For better stacking of cups, the shelves can be folded down as show on the picture below.

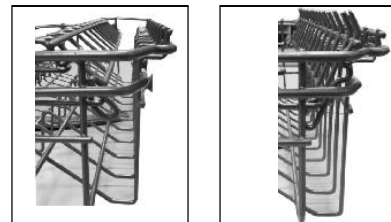

E. Folding Spikes of Lower Basket

For better stacking of pots and pans, the spikes can be folded down as show on the picture below.



F. Loading the Cutlery Basket

Cutlery should be placed in the cutlery rack separately from each other in the appropriate positions, and do make sure the utensils do not nest together, this may cause bad performance.

For a top quality cleaning, place the silverware in the basket making sure that:

- They do not nest together.
- Silverware is placed with the male face up.
- Long utensils in the middle.

⚠ WARNING!



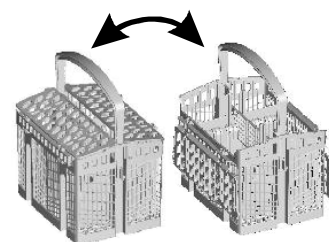

- Do not let any item extend through bottom.
- Always load sharp utensils with the sharp pointing down!



6. Starting a washing program

Wash Cycle Table

 **NOTE:** (★) Means: Rinse-aid dispenser needs to be filled.

Program	Cycle Selection Information	Description of Cycle	Detergent pre/main	Running time(min)	Energy (Kwh)	Water (L)	Rinse Aid
 Intensive	For heaviest soiled crockery, and normally soiled pots, pans, dishes etc with dried on soiling.	Pre-wash(50 °C) Wash (60 °C) Rinse Rinse Rinse(65°C) Drying	<u>5/30g</u> (1 or 2 pieces)	160	1.5	18.5	★
 Normal	For normally soiled loads, such as pots, plates, glasses and lightly soiled pans.	Prewash(45°C) Wash (55 °C) Rinse Rinse (65 °C) Drying	5/30g	180	1.25	15	★
ECO (*EN 50242)	This is standard programme, it is suitable to clean normally soiled tableware and it is the most efficient programme in terms of its combined energy and water consumption for that type of tableware.	Prewash Wash (45 °C) Rinse(65°C) Drying	5/30g	190	0.97	11	★
 Glass	For lightly soiled crockery and glass.	Pre-wash Wash (40 °C) Rinse Rinse(60°C) Drying	5/30g	120	0.85	14.5	★
90 min 90 Min	For normally soiled loads that need quick wash.	Wash(65°C) Rinse Rinse (65°C) Drying	35g	90	1.35	12.5	★
 Rapid	A shorter wash for lightly soiled loads that do not need drying.	Wash (45 °C) Rinse Rinse (55 °C)	20g	40	0.75	11.5	

 **NOTE:**

*EN 50242 : This program is the test cycle. The information for comparability test in accordance with EN 50242, as follows:

- Capacity: 14 setting
- Position Upper basket: lowest position
- Rinse aid setting: 6
- PI:0.49W; P₀:0.45W.

Left-on mode duration: Power will be cut off automatically after program finished for 30 minutes.

Turning On the Appliance

Starting a cycle wash

- 1** Draw out the lower and upper basket, load the dishes and push them back.
It is recommended to load the lower basket first, then the upper one (see the section entitled "Loading the Dishwasher").
- 2** Pour in the detergent (see the section entitled "Salt, Detergent and Rinse Aid").
- 3** Insert the plug into the socket. The power supply is 220-240 VAC /50 HZ, the specification of the socket is 10A 250VAC. Make sure that the water supply is turned on to full pressure.
- 4** Close the door, press the Power button, to switch on the machine.
- 5** Press the program button, the wash program will be changed as follows direction:
Intensive->Normal->ECO->Glass->90 Min->Rapid;
If a program is selected, the response light will turn on. Then press the Start/Pause button, the dishwasher will start its cycle.

NOTE:

When you press the Start/Pause button to pause during washing, the running indicator will stop blinking and the dishwasher will mooring every minute unless you press the Start/Pause button to start.

Changing the program mid-cycle

Premise:

- 1 A running cycle can only be changed if it has only been running for a short time. Otherwise, the detergent may have already been released, and the appliance may have already drained the wash water. If this is the case, the detergent dispenser must be refilled (see the section entitled "Loading the Detergent").
- 2 Press the Start/Pause button, the machine will be in standby state, press the program button more than 3s then press the change the program to the desired cycle setting (see the section entitled "Starting a wash cycle. . .").

NOTE:

If you open the door during a wash cycle, the machine will pause. The program light will stop blinking and the buzzer will mooring every minute unless you close the door. After you close the door, the machine will keep on working after 10 seconds.

If your model has memory function, and if the power is cut by accident, the machine will continue the selected program when the power recovers.

Forgot to Add a Dish?

A forgotten dish can be added any time before the detergent cup opens.

- 1 Press the Start/Pause button
- 2 Open the door a little to stop the washing.
- 3 After the spray arms stop working, you can open the door completely.
- 4 Add forgotten dishes.
- 5 Close the door
- 6 Press the Start/Pause Button. The dishwasher will run after 10 seconds.

At the end of the Wash Cycle

When the working cycle has finished, the buzzer of the dishwasher will sound for 8 seconds, then stop. Turn off the appliance using the Power switch button, shut off the water supply and open the door of the dishwasher. Wait for a few minutes before unloading the dishwasher to avoid handling the dishes and utensils while they are still hot and more susceptible to break. They will also dry better.

■ Switching Off the Dishwasher

The program light is on but is not blinking, only in this case has the program ended.

1. Switch off the dishwasher by pressing the Power button.
2. Turn off the water tap!

■ Open the door carefully.

Hot dishes are sensitive shocks. The dishes should cool down for around 15 minutes before removing from the appliance.

Open the dishwasher's door, leave it ajar and wait a few minutes before removing the dishes. In this way they will be cooler and the drying will be improved

■ Unloading the dishwasher

It is normal for the dishwasher to be wet inside.

Empty the lower basket first and then the upper one. This will avoid water dripping from the upper Basket onto the dishes in the lower one.

 **WARNING!** It is dangerous to open the door mid-cycle, as hot steam may scald you.

7. Maintenance and Cleaning

Filter System

The filter prevents larger remnants of food or other objects from getting inside the pump. The residues may block the filter, in this case they must be removed.

The filter system consists of a coarse filter, a flat (Main filter) and a microfilter (Fine filter).

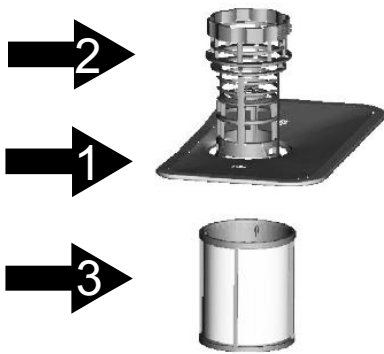

Main filter **1**

Food and soil particles trapped in this filter are pulverized by a special jet on the lower spray arm and washed down the drain.

Coarse filter **2**

Larger items, such as pieces of bones or glass, that could block the drain are trapped in the coarse filter. To remove the items caught by the filter, gently squeeze the tap on the top of this filter and lift out.

Fine filter **3**

This filter holds soil and food residues in the sump area and them from being redeposited on the dishes during wash cycle.

Filter assembly

The filter efficiently removes food particles from the wash water, allowing it to be recycled during the cycle. For best performance and results, the filter must be cleaned regularly. For this reason, it is a good idea to remove the larger food particles trapped in the filter after each wash cycle by rinsing the semicircular filter and cup under running water. To remove the filter device, pull the cup handle in the upward direction.

⚠ WARNING!

- The dishwasher must never be used without the filters.
- Improper replacement of the filter may reduce the performance level of the appliance and damage dishes and utensils.

1

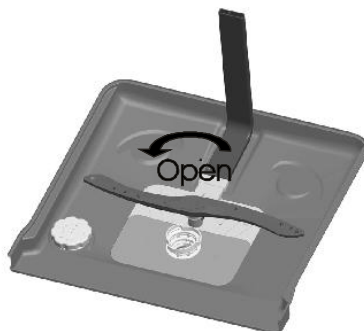

Step 1: Turn the filter counterclockwise,

2

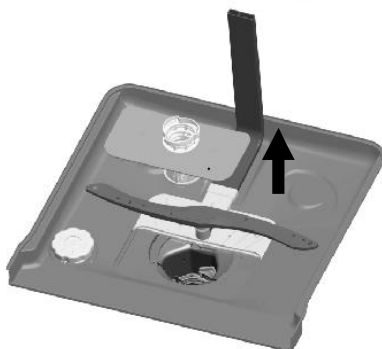

Step 2: lift the filter assy up



NOTE: *When following this procedure from step 1 to step 2, the filter system will be removed; when following it from Step 2 to Step 1, the filter system will be installed.*

Remarks:

- After each cycle, check for any debris in the filter to avoid future blockage.
- By unscrewing the coarse filter, you can remove the filter system. Remove any food remnants and clean the filters under running water.

⚠ NOTE: The entire filter assembly should be cleaned once a week.

Cleaning the Filter

To clean the coarse filter and the fine filter, use a cleaning brush. Reassemble the filter parts as shown in the figures on the last page and reinsert the entire assembly in the dishwasher, positioning it in its seat and pressing downwards.

⚠ WARNING! When cleaning the filters, do not knock on them. Otherwise, the filters could be contorted and the performance of the dishwasher could be decreased.

Caring for the Dishwasher

The control panel can be cleaned by using a lightly dampened cloth. After cleaning, make sure to dry it thoroughly.

For the exterior, use a good appliance polish wax.

Never use sharp objects, scouring pads or harsh cleaners on any part of the dishwasher.

Cleaning the Door

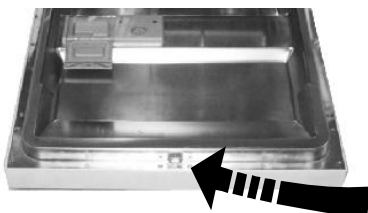

To clean the edge around the door, you should only use a soft, ward and damp cloth.

To avoid penetration of water into the door lock and electrical components, do not use a spray cleaner of any kind.

⚠ WARNING!

- Never use a spray cleaner to clean the door panel as it may damage the door lock and electrical components.
- Abrasive agents or some paper towels should not be used because of the risk of scratching or leaving spots on the stainless steel surface.

Winterizing

please take frost protection measures on the dishwasher in winter. Every time after washing cycles, please operate as follows:

1. Cut off the electrical power to the dishwasher at the supply source.
2. Turn off the water supply and disconnect the water inlet pipe from the water valve.
3. Drain the water from the inlet pipe and water valve. (Use a pan to gather the water)
4. Reconnect the water inlet pipe to the water valve.
5. Remove the filter at the bottom of the tub and use a sponge to soak up water in the sump.

⚠ NOTE: If your dishwasher cannot work because of the ice, please contact professional service persons.

Cleaning the Spray Arms

It is necessary to clean the spray arms regularly for hard water chemicals will clog the spray arm jets and bearings.

To remove the upper spray arm, hold the nut, rotate the arm clockwise to remove it.

To remove the lower spray arm, pull out the spray arm upward.

Wash the arms in soapy and warm water and use a soft brush to clean the jets. Replace them after rinsing them thoroughly.

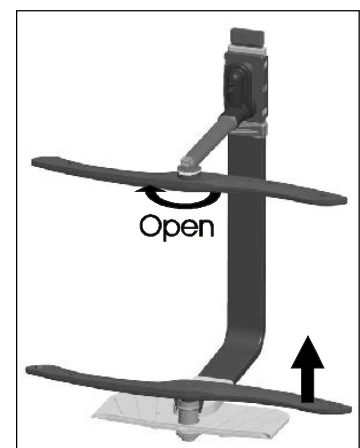

How to Keep Your Dishwasher in Shape

■ After Every Wash

After every wash, turn off the water supply to the appliance and leave the door slightly open so that moisture and odours are not trapped inside.

■ Remove the Plug

Before cleaning or performing maintenance, always remove the plug from the socket.

■ No Solvents or Abrasive Cleaning

To clean the exterior and rubber parts of the dishwasher, do not use solvents or abrasive cleaning products. Only use a cloth with warm soapy water.

To remove spots or stains from the surface of the interior, use a cloth dampened with water and a little vinegar, or a cleaning product made specifically for dishwashers.

■ When not in Use for a Long Time

It is recommended that you run a wash cycle with the dishwasher empty and then remove the plug from the socket, turn off the water supply and leave the door of the appliance slightly open. This will help the door seals to last longer and prevent odours from forming within the appliance.

■ Moving the Appliance

If the appliance must be moved, try to keep it in the vertical position. If absolutely necessary, it can be positioned on its back.

■ Seals

One of the factors that cause odours to form in the dishwasher is food that remains trapped in the seals. Periodic cleaning with a damp sponge will prevent this from occurring.

8. Installation instruction

Positioning the Appliance

Position the appliance in the desired location. The back should rest against the wall behind it, and the sides, along the adjacent cabinets or walls. The dishwasher is equipped with water supply and drain hoses that can be positioned either to the right or the left sides to facilitate proper installation.

Levelling the Appliance

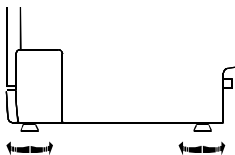

Once the appliance is positioned for levelling, the height of the dishwasher may be altered by adjusting the screwing level of the feet. In any case, the appliance should not be inclined more than 2°.

About Power Connection

⚠ WARNING!

For personal safety:

- Do not use an extension cord or an adapter plug with this appliance.
- Do not, under any circumstances, cut or remove the earthing connection from the power cord.

Electrical Requirements

Please look at the rating label to know the rating voltage and connect the dishwasher to the appropriate power supply. Use the required fuse 10 amp, time delay fuse or circuit breaker recommended and provide separate circuit serving only this appliance.

Electrical Connection

⚠ **Ensure that proper earthing exists before use**

Ensure the voltage and frequency of the power being corresponds to those on the rating plate. Only insert the plug into an electrical socket which is earthed properly. If the electrical socket to which the appliance must be connected is not appropriate for the plug, replace the socket, rather than using a adaptors or the like as they could cause overheating and burns.

Water Connection

Cold Water Connection

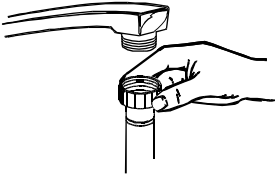

Connect the cold water supply hose to a threaded 3/4 (inch) connector and make sure that it is fastened tightly in place.
If the water pipes are new or have not been used for an extended period of time, let the water run to make sure that the water is clear. This precaution is needed to avoid the risk of the water inlet to be blocked and damage the appliance.

⚠ WARNING! Please close the hydrant after use.

Drain hose Connection

Insert the drain hose into a drain pipe with a minimum diameter of 40mm, or let it run into the sink, making sure to avoid bending or crimping it. The height of the drain pipe must be less than 1000mm.

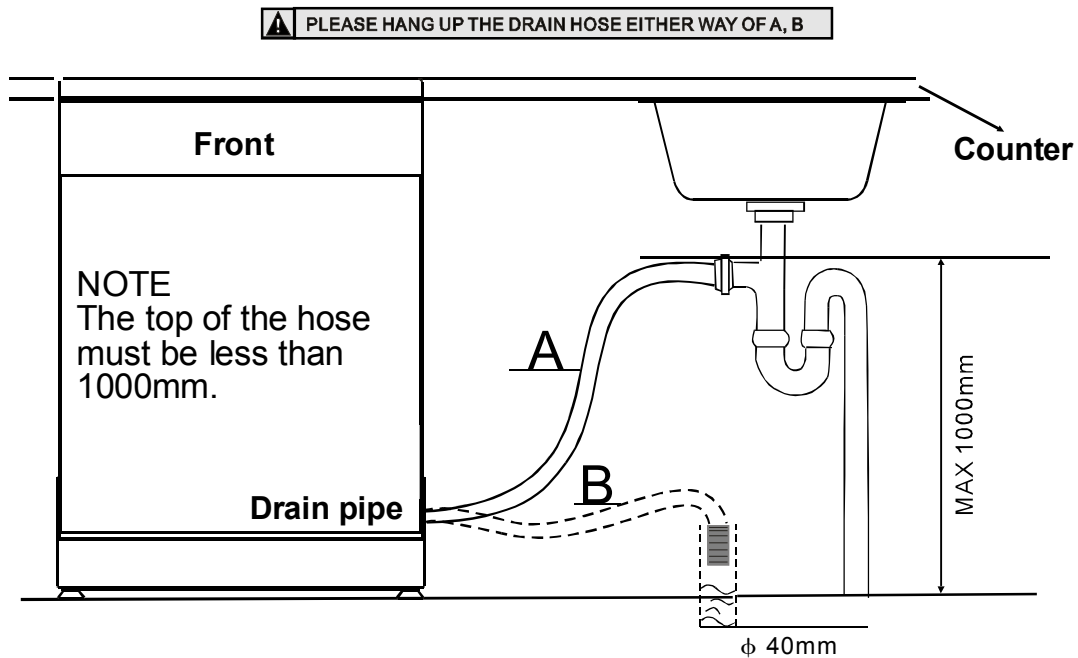

How to Drain Excess Water From Hoses

If the sink is 1000 higher from the floor, the excess water in hoses cannot be drained directly into the sink. It will be necessary to drain excess water from hoses into a bowl or suitable container that is held outside and lower than the sink.

Water Outlet

Connect the water drain hose. The drain hose must be correctly fitted to avoid water leaks. Ensure that the water drain hose is not kinked or squashed.

Extension Hose

If you need a drain hose extension, make sure to use a similar drain hose. It must be no longer than 4 metres; otherwise the cleaning effect of the dishwasher could be reduced.

Syphon Connection

The distance between the drain connection and the bottom of the appliance must not be longer than 1000mm. The water drain hose should be fixed.

Start of Dishwasher

The following things should be checked before starting the dishwasher.

- 1** The dishwasher is levelled and fixed properly
- 2** The inlet valve is open
- 3** Fill hose connections are fully tightened and not leaking
- 4** The wires are tightly connected
- 5** The power is switched on
- 6** The inlet and drain hoses are knotted
- 7** All packing materials and printings have been removed from the dishwasher.



Attention: *After installation, please make sure to keep this manual.*

The content of this manual is very helpful to the users.

9. Troubleshooting Tips

Before Calling for Service

Reviewing the charts on the following pages may save you from calling for service.



	<i>Problem</i>	<i>Possible Causes</i>	<i>What to Do</i>
Technical problems	<i>Dishwasher doesn't start</i>	Fuse blown, or the circuit breaker tripped	Replace fuse or reset circuit breaker. Remove any other appliances sharing the same circuit with the dishwasher
		Power supply is not turned on	Make sure the dishwasher is turned on and the door is closed securely. Make sure the power cord is properly plugged into the wall socket.
		Water pressure is low	Check that the water supply is connected properly and the water is turned on.
		Door of dishwasher not properly closed.	Make sure to close the door properly and latch it.
<i>water not pumped from dishwasher</i>	Kink in drain hose	Check drain hose.	
	Filter clogged	Check the coarse filter (see section titled "Cleaning The Filter")	
	Kitchen sink clogged	Check the kitchen sink to make sure it is draining well. If the kitchen sink is not draining properly, you may need a plumber rather than a serviceman for dishwashers.	
General problems	<i>Suds in the tub</i>	Improper detergent	Use only the special dishwasher detergent to avoid suds. If this occurs, open the dishwasher and let suds evaporate. Add 1 gallon of cold water to the tub. Close and latch the dishwasher, then select any cycle. Dishwasher will drain out the water at the first step. Open the door after draining is over and check if the suds have disappeared.
		Spilled rinse-aid	Always wipe up rinse-aid spills immediately.
	<i>Stained tub interior</i>	Detergent with colorant was used	Make sure that the detergent is the one without colorant.
	<i>White film on inside surface</i>	Hard water minerals	To clean the interior, use a damp sponge with dishwasher detergent and wear rubber gloves. Never use any other cleaner than dishwasher detergent for the risk of foaming or suds.
	<i>There are rust stains on cutlery</i>	The affected items are not corrosion resistant.	
A program was not run after dishwasher salt was added. Traces of salt have gotten into the wash cycle.		Always run the quick wash program without any crockery in the dishwasher and without selecting the Turbo function (if present), after adding dishwasher salt.	
The lid of the softer is loose		Check the lid. Ensure the fix is fine.	
Noise	<i>Knocking noise in the wash cabinet</i>	A spray arm is knocking against an item in a basket	Interrupt the program, and rearrange the items which are obstructing the spray arm.
	<i>Rattling noise in the wash cabinet</i>	Items of crockery are loose in the wash cabinet	Interrupt the program, and rearrange the items of crockery.
	<i>Knocking noise in the water pipes</i>	This may be caused by on-site installation or the cross-section of the piping.	This has no influence on the dishwasher function. If in doubt, contact a qualified plumber.



Unsatisfactory washing result

<i>Problem</i>	<i>Possible Causes</i>	<i>What to Do</i>
<i>The dishes are not clean</i>	The dishes were not loaded correctly.	See notes in "Loading the Dishwasher Baskets".
	The program was not powerful enough.	Select a more intensive program. See "Wash Cycle Table".
	Not enough detergent was dispensed.	Use more detergent, or change your detergent.
	Items are blocking the path of spray arms.	Rearrange the items so that the spray can rotate freely.
	The filter combination in the base of wash cabinet is not clean or is not correctly fitted. This may cause the spray arm jets to get blocked.	Clean and/or fit the filter combination correctly. Clean the spray arm jets. See "Cleaning the Spray Arms".
<i>Cloudiness on glassware</i>	Combination of soft water and too much detergent.	Use less detergent if you have soft water and select a shorter cycle to wash the glassware and to get them clean.
<i>Black or gray marks on dishes</i>	Aluminum utensils have rubbed against dishes.	Use a mild abrasive cleaner to eliminate those marks.
<i>Detergent left in dispenser cups</i>	Dishes block detergent cups.	Re-loading the dishes properly.

Unsatisfactory drying result

<i>The dishes are not drying</i>	Improper loading	Load the dishwasher as suggested in the directions.
	Too little rinse-aid	Increase the amount of rinse-aid/refill the rinse-aid dispenser.
	Dishes are removed too soon	Do not empty your dishwasher immediately after washing. Open the door slightly so that the steam can escape. Begin unloading the dishwasher only once the dishes are barely warm to the touch. Empty the lower basket first to prevent any water from dripping into the lower basket.
	Wrong program has been selected	With a short program, the washing temperature is lower, decreasing cleaning performance. Choose a program with a long washing time.
	Use of cutlery with a low-quality coating	Water drainage is more difficult with these items. Cutlery or dishes of this type are not suitable for washing in the dishwasher.

Error Codes

In case of malfunctions, the appliance will display error codes to warn you:

<i>Codes</i>	<i>Meanings</i>	<i>Possible Causes</i>
The Rapid light flicker fleetly	Longer inlet time.	Faucet is not opened, or water intake is restricted, or water pressure is too low.
The Glass light flicker fleetly	Overflow.	Some element of dishwasher leaks.

▲ WARNING!

- If overflow occurs, turn off the main water supply before calling a service.
- If the base pan overflows:
 - Turn off the main water supply before calling for service
 - Remove the excess water before restarting the dishwasher.

Technical Information

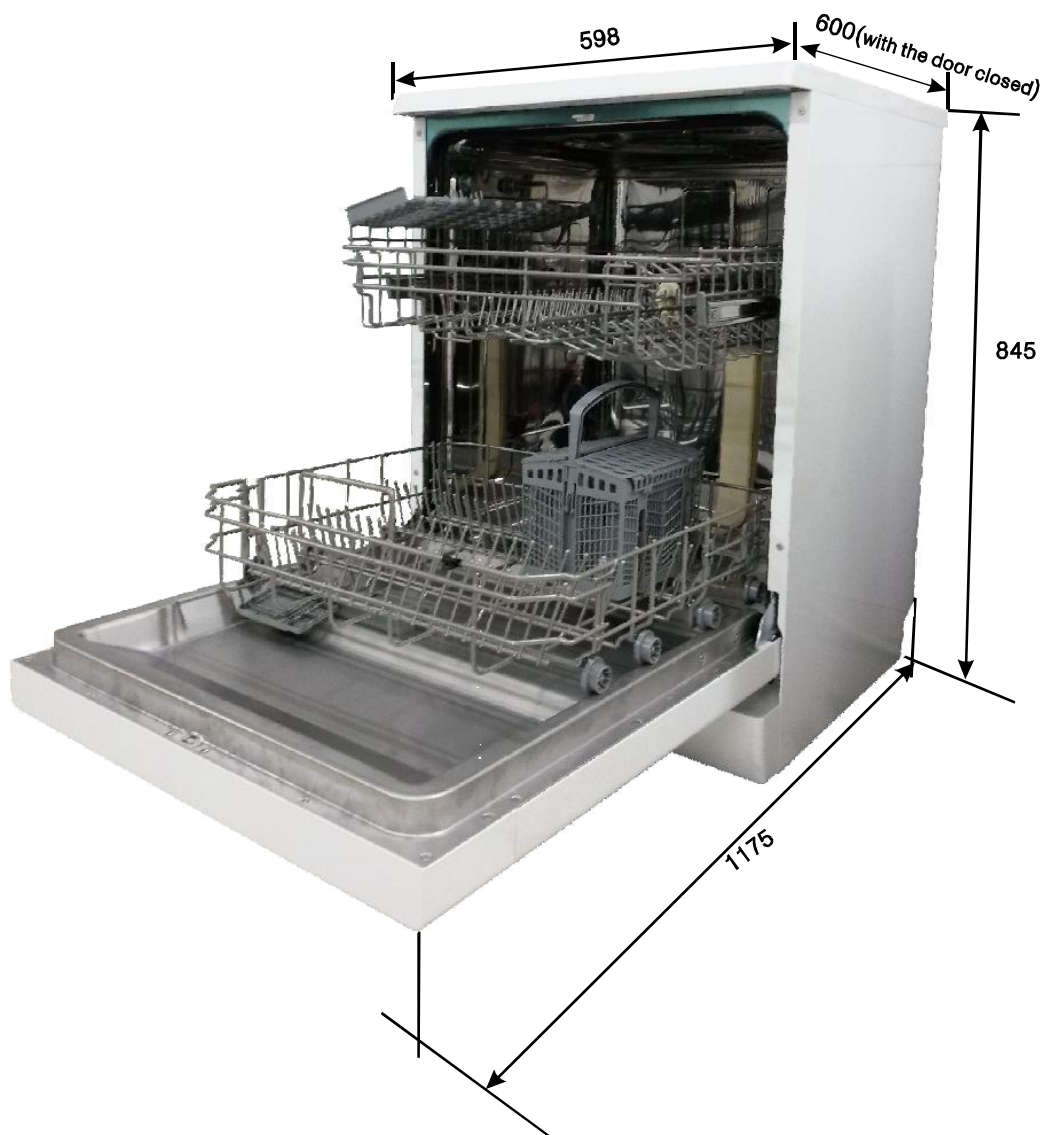

Height :	845mm
Width :	598 mm
Depth :	600mm(with the door closed)
Water pressure:	0.04-1.0MPa
Power supply:	see rating label
Capacity:	14 place settings

Product fiche

Sheet of household dishwasher according to EU Directives 1016/2010 & 1059/2010:

Manufacturer	BRANDT
Type / Description	DFH14617W,DFH14617X
Standard place settings	14
Energy efficiency class ①	A+
Annual energy consumption ②	290 kWh
Energy consumption of the standard cleaning cycle	0.97 kWh
Power consumption of off-mode	0.45 W
Power consumption of left-on mode	0.49 W
Annual water consumption ③	3080 liter
Drying efficiency class ④	A
Standard cleaning cycle ⑤	ECO 45°C
Program duration of the standard cleaning cycle	190 min
Noise level	47 dB(A) re 1 pW
Mounting	Free standing
Could be built-in	No
Height	84.5 cm
Width	59.8 cm
Depth (with connectors)	60 cm
Power consumption	1930 W
Rated voltage / frequency	230 V~ 50 Hz
Water pressure (flow pressure)	0.4-10 bar = 0.04-1 MPa

NOTE:

- ①** A + + + (highest efficiency) to D (lowest efficiency)
- ②** Energy consumption “290” kWh per year, based on 280 standard cleaning cycles using cold water fill and the consumption of the low power modes. Actual energy consumption will depend on how the appliance is used.
- ③** Water consumption “3080” litres per year, based on 280 standard cleaning cycles. Actual water consumption will depend on how the appliance is used.
- ④** A (highest efficiency) to G (lowest efficiency)
- ⑤** This program is suitable for cleaning soiled normally soiled tableware and that it is the most efficient programme in terms of its combined energy and water consumption for that type of tableware.

The device meets the European standards and the directives in the current version at delivery:

- LVD 2006/95/EC
- EMC2004/108/EC
- ErP 2009/125/EC

The above values have been measured in accordance with standards under specified operating conditions. Results may vary greatly according to quantity and pollution of the dishes, water hardness, amount of detergent, etc.

The manual is based on the European Union's standards and rules.

Loading the baskets according to En50242:

1. Upper basket:

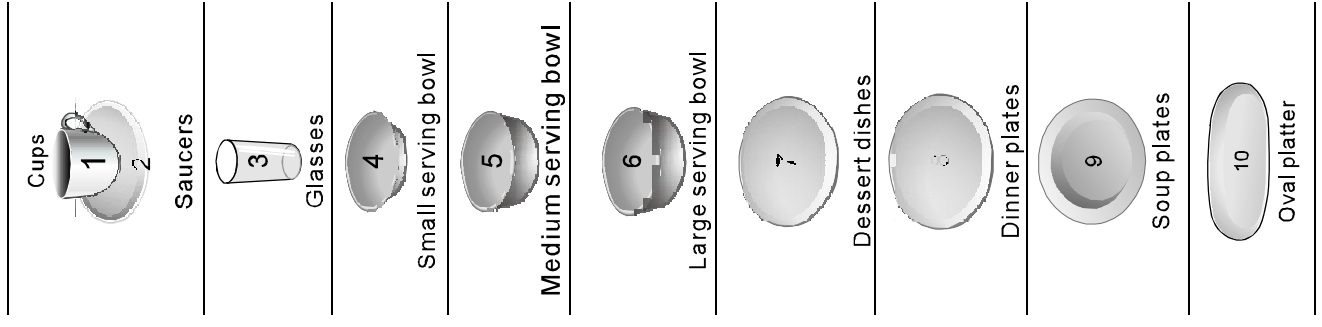
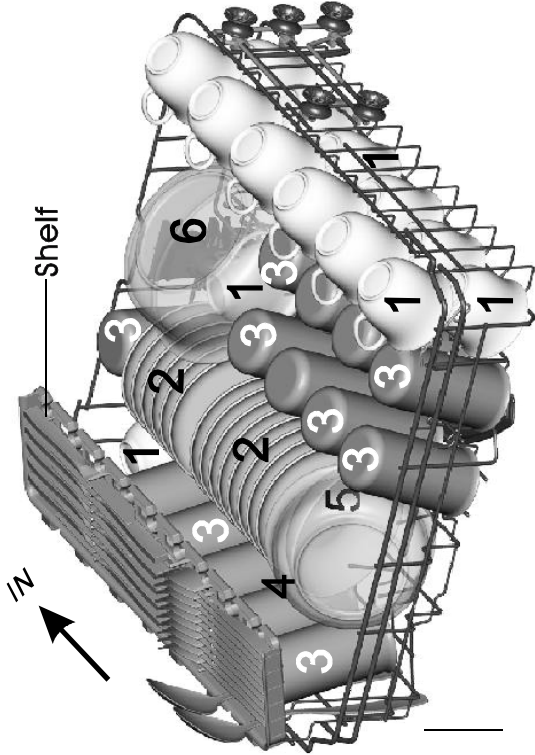

2. Lower basket:

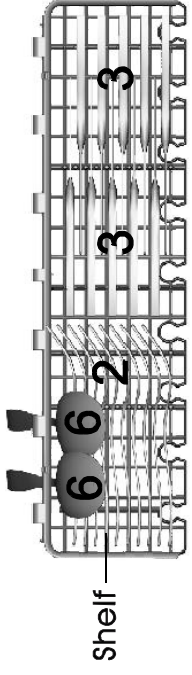
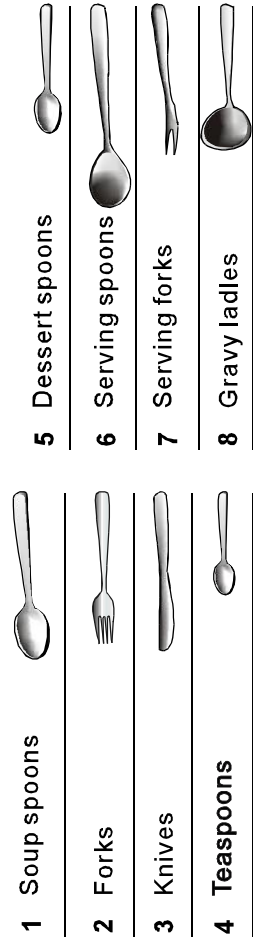
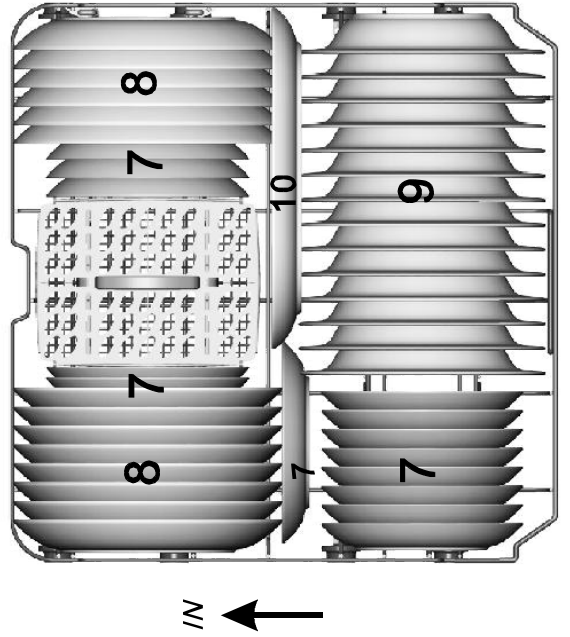

Shelf

Note: Please place the light flat wares on the shelf. The total weight is less than 1.5kg.

3. Cutlerly basket:

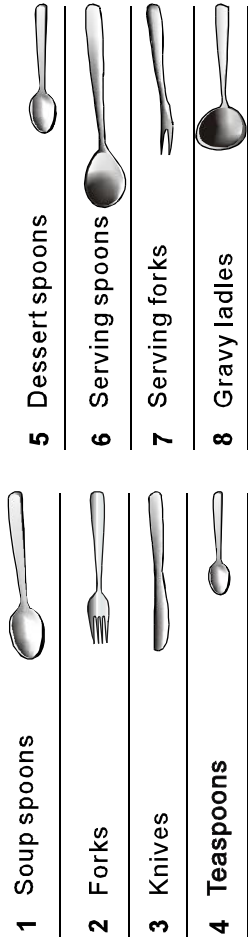
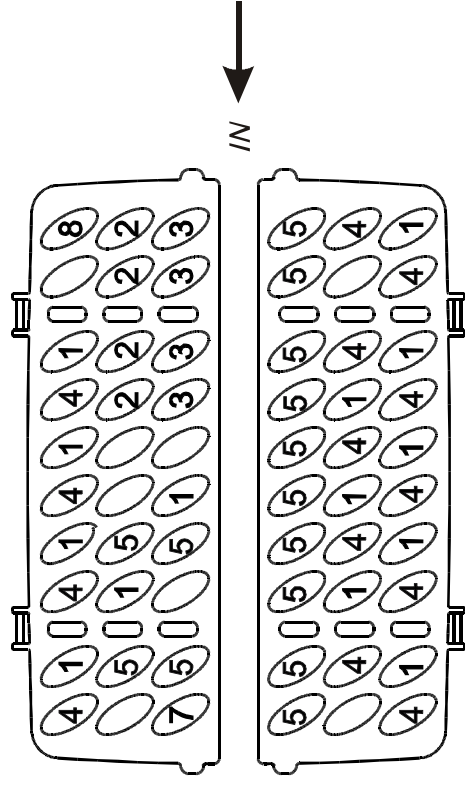

Information for comparability tests in accordance with EN 50242

Capacity: 14 place settings

Position of the upper basket: lower position

Programme: ECO

Rinse aid setting: 6

Softener setting: H3

EN After Sales Service:

Any maintenance on your equipment should be undertaken by:

-Either your dealer,

-Or another qualified mechanic who is an authorized agent for the brand appliances.

When making an appointment, state the full reference of your equipment (model, type and serial number). This information appears on the manufacturer's nameplate attached to your equipment.